

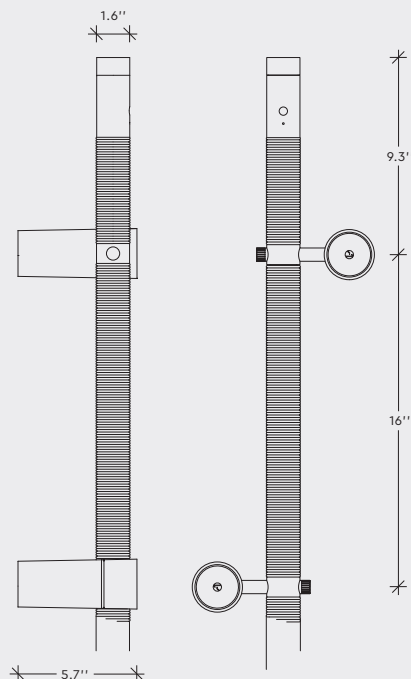

X-tendable

Enrich your table with the X-tendable pendant by ONE A. The sleek X-tendable pendant consists of an anodized base with a beautiful hand-wrapped leather cord detail – honoring ONE A's design philosophy.

The pendant is ideal for kitchen-, dining- and meeting tables as the integrated dimmer enables you to create the desired atmosphere, and honeycombs in the lamp-heads prevent glaring



The crossed-out wheeled bin symbol indicates that the item should be disposed of separately from household waste. The item should be handed in for recycling in accordance with local environmental regulations for waste disposal
For more information, please contact info@onea.dk

X-TENDABLE

DATA

Collection	ONE A
Product	X-tendable
Article no.	1N11.4083.XX01.00ZZ (X2) 1N11.4084.XX01.00ZZ (X4) 1N11.4085.XX01.00ZZ (X6) 1N11.4086.XX01.00ZZ (X8)

SPECIFICATIONS

Material	Aluminium and leather
Labelling	ETL PENDING

ELECTRICAL SPECIFICATIONS

Voltage	120V / GU10 max. rating: LED 8W per light engine
Insulation class	Class I ⊕
IP protection grade	IP20

Light Source & Junction Kit	MR16 LED (light source not included)
-----------------------------	--------------------------------------

For further support contact LITES ON WEST
245 West 29th Street, 6th floor | NY, NY 10001
T: 212 775 6363 | F: 212 775 0355
E: info@litesonwest.com

NOTE

When using honey combs the lumen output will be reduced with 30% in efficiency

XX-COLOUR CODES

92 Black Pearl	93 Elephant Grey
97 Gold	98 Silver

ZZ-COLOUR CODES

92 Black Leather	94 Tanned Leather
95 Brown Leather	96 Green Leather

SUSPENSION

	A	B	Max. Effect (w)	Weight
X2	2.80ft	-	16	4.6lb
X4	5.42ft	-	36	11lb
X6	8.04ft	3.80ft	48	14lb
X8	10.7ft	5.11ft	64	18lb

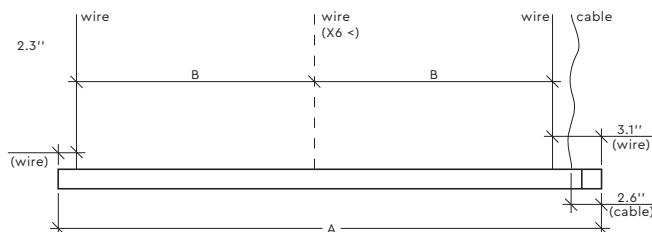

NOTE

9.84'' Cord included.

IMPORTANT INFORMATION

Installation and mounting must be performed by a certified electrician only, and instructions must be followed.

Always shut the power circuit off before starting work.

In some countries electrical installation work may only be carried out by an authorized electrical contractor. Please contact your local electricity authority for advice.

If the external flexible cable is damaged, it **MUST** be replaced by a special cable exclusively available from the manufacture.

The light sources contained within this fixtures **MUST** only be replaced by the manufacture or a similarly qualified person.

CLEANING AND MAINTENANCE:

Use a soft moist cloth for cleaning. No further maintenance is required.

WARRANTY:

If the product is defect, please contact your supplier immediately. Please note that warranty will not apply in case of wrongful use or if unskilled personnel attempts to repair.

X-TENDABLE suspension wire

ASSEMBLY USING STORM OUTPUT

Suspension wire can be mounted in Storm Output, for further information refer to Storm Output's technical information.

Feed the accompanying steel wire through the small hole in Storm Output, then fasten the screw

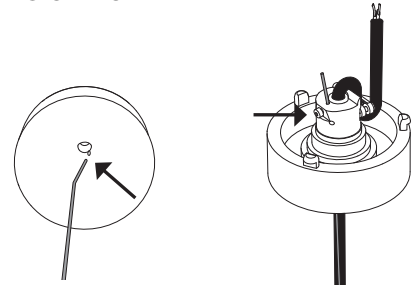

ASSEMBLY USING WIRE SUSPENSION

STEP 1

Mount the wire suspension to the ceiling with a screw.

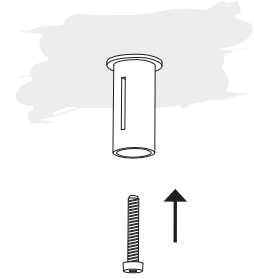

STEP 2

Mount the wire lock in the wire suspension.

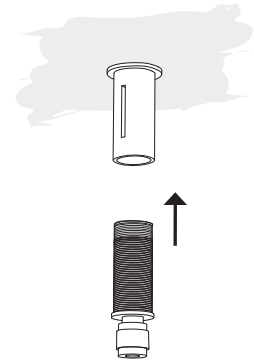

STEP 3

Guide the wire through the wire lock

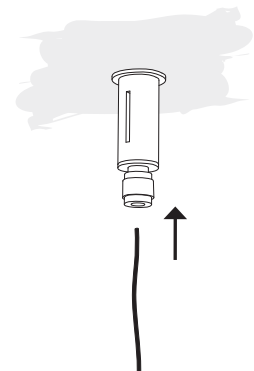

IMPORTANT INFORMATION

Installation and mounting must be performed by a certified electrician only, and instructions must be followed.

Always shut the power circuit off before starting work.

In some countries electrical installation work may only be carried out by an authorized electrical contractor. Please contact your local electricity authority for advice.

If the external flexible cable is damaged, it **MUST** be replaced by a special cable exclusively available from the manufacture.

The light sources contained within this fixtures **MUST** only be replaced by the manufacture or a similarly qualified person.

CLEANING AND MAINTENANCE:

Use a soft moist cloth for cleaning. No further maintenance is required.

WARRANTY:

If the product is defect, please contact your supplier immediately. Please note that warranty will not apply in case of wrongful use or if unskilled personnel attempts to repair.

X-TENDABLE wire suspension

STEP 4

Then pull the wire out through the slot

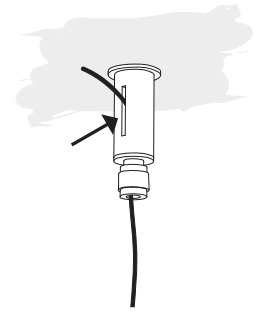

STEP 5

Make sure main power is off!

Connect wire to power outlet. Make sure to obtain cable strain relief, check power outlet for instructions.

N - Neutral (black)

⊕ - Ground (Green/Yellow)

L - Line (White)

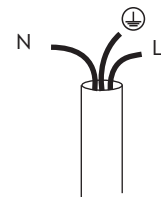

IMPORTANT INFORMATION

Installation and mounting must be performed by skilled personnel only, and instructions must be followed.

Always shut the power circuit off before starting work.

In some countries electrical installation work may only be carried out by an authorized electrical contractor. Please contact your local electricity authority for advice.

If the external flexible cable is damaged, it MUST be replaced by a special cable exclusively available from the manufacture.

The light sources contained within this fixtures MUST only be replaced by the manufacture or a similarly qualified person.

CLEANING AND MAINTENANCE:

Use a soft moist cloth for cleaning. No further maintenance is required.

WARRANTY:

If the product is defect, please contact your supplier immediately. Please note that warranty will not apply in case of wrongful use or if unskilled personnel attempts to repair.

X-TENDABLE

LIGHT SOURCE REPLACEMENT

STEP 1

Remove the front tube by gently rotating.

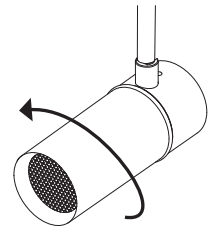

STEP 2

Pull back the spring.

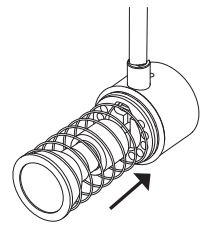

STEP 3

Disconnect the light source and replace with the new light source.

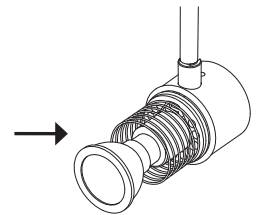

STEP 4

Gently release the spring. Then mount the front tube by slightly rotating the tube into place.

